



Meaningful Innovation.

WEEE Number: 80133970

# INSTRUCTION MANUAL

## MICROWAVE SENSOR



COMPATIBLE WITH  
V-TAC LED  
RANGE (UPTO 600W)

**05** YEAR  
WARRANTY\*

**IP65**  
RATING

### TECHNICAL DATA

MODEL	VT-80301	POWER CONSUMPTION	Approx. 0.9W
SKU	23164	AMBIENT LIGHT	<3-2000 LUX (Adjustable)
INPUT POWER	AC: 220-240V, 50/60 Hz	INSTALLATION HEIGHT	1.5-3.5m
RATED LOAD	Max. 1200W ☼ 300W ⚡+LED	POWER CONSUMPTION	Approx 0.9w
TIME DELAY	Min. 10sec ±3sec Max. 12min ±1min	DETECTION MOTION SPEED	0.6-1.5 m/s
DETECTION RANGE	180°	HF SYSTEM	5.8Ghz CW Radar, ISM Band
DETECTION DISTANCE	5-12m Adjustable	DIMENSION	119.5x80x51.5 mm
DETECTION MOVING SPEED	0.6-1.5m/s		
WORKING TEMPERATURE	-20°C to +40°C		

### INTRODUCTION & WARRANTY

Thank you for selecting and buying V-TAC product. V-TAC will serve you the best. Please read these instructions carefully before starting the installation and keep this manual handy for future reference. If you have any another query, please contact our dealer or local vendor from whom you have purchased the product. They are trained and ready to serve you at the best. The warranty is valid for 5 years from the date of purchase. The warranty does not apply to damage caused by incorrect installation or abnormal wear and tear. The company gives no warranty against damage to any surface due to incorrect removal and installation of the product.

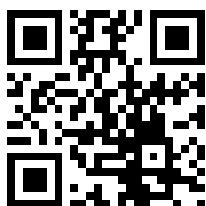

#### MULTI-LANGUAGE MANUAL QR CODE

Please scan the QR code to  
access the manual in multiple languages.

In case of any query/issue with the product, please reach out to us at: [support@v-tac.eu](mailto:support@v-tac.eu)  
For More products range, inquiry please contact our distributor or nearest dealers.  
V-TAC EUROPE LTD. Bulgaria, Plovdiv 4000, bul.L.Karavelow 9B

## WARNING

1. Please make sure to turn off the power before starting the installation.
2. Installation must be performed by a qualified electrician.



This marking indicates that this product should not be disposed of with other household wastes.



Caution, risk of electric shock.

## FUNCTION

1. Can identify day and night: It can work in the daytime and at night when it is adjusted on the "sun" position (max). It can work in the ambient light less than 3LUX when it is adjusted on the "3" position (min). As for the adjustment pattern, please refer to the testing pattern.
2. SENS adjustable: It can be adjusted according to using location. The detection distance of low sensitivity could be only 5m and high sensitivity could be 15m which fits for large room.
3. Time-Delay is added continually: When it receives the second induction signals within the first induction, it will restart to time from the moment.
4. Time—Delay is adjustable. It can be set according to the consumer's desire. The minimum time is  $10\text{sec} \pm 3\text{sec}$ . The maximum is  $12\text{min} \pm 1\text{min}$ .

**NOTE: the high-frequency output of the HF sensor is  $<0.2\text{mW}$ - that is just one 5000th of the transmission power of a mobile phone or the output of a microwave oven, the baby can't touch it**

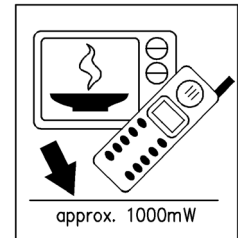
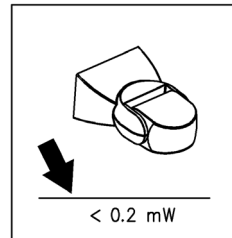

## INSTALLATION

- Loosen the screw on the bottom and unload the bottom (refer to the figure1).
- Pass the power wire through the hole with gasket in the bottom. Connect the power wire into connection-wire column according to the connection-wire diagram.
- Fix the bottom with inflated screw on the selected position (refer to the figure2).
- Install back the sensor on the bottom, tighten the screw and then test it.

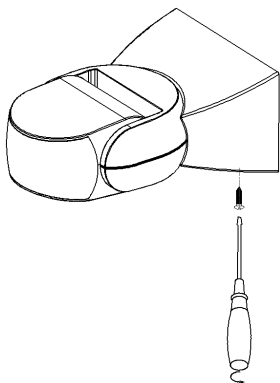

Figure 1

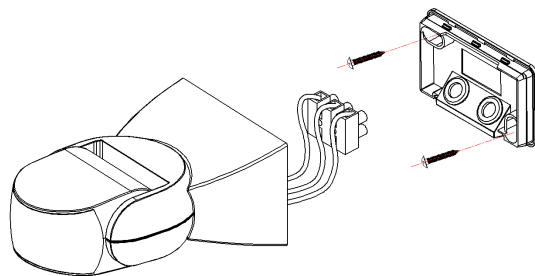
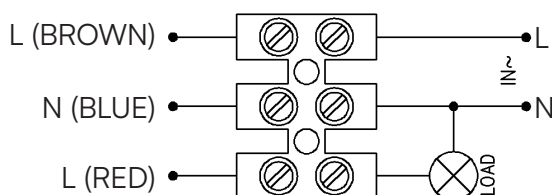

Figure 2

## CONNECTION-WIRE DIAGRAM



---

## **TEST**

- Turn the LUX knob clockwise on the maximum (sun). Turn the SENS knob clockwise on the maximum (+). Turn the TIME knob anti-clockwise on the minimum (10s).
- When you switch on the power, the light will be on at once. And 10sec±3sec later the light will be off automatically. Then if the sensor receives induction signal again, it can work normally.
- When the sensor receives the second induction signals within the first induction, it will restart to time from the moment.
- Turn LUX knob anti-clockwise on the minimum (3). If the ambient light is less than 3LUX (darkness), the inductor load could work when it receives induction signal.

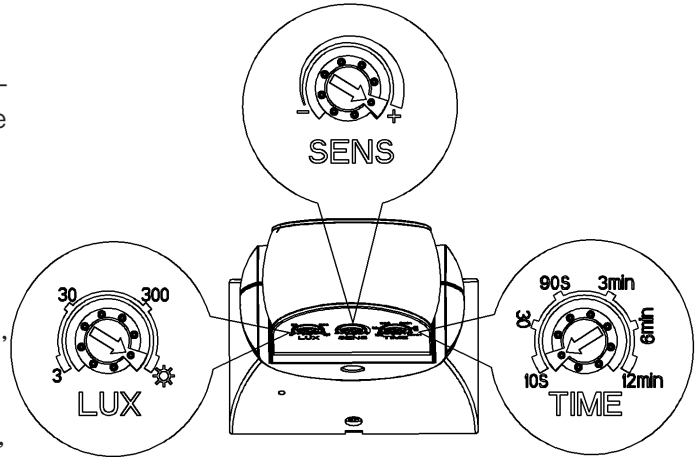

**Note: when testing in daylight, please turn LUX knob to ☀ (SUN) position, otherwise the sensor lamp could not work!**

## **NOTES**

- Electrician or experienced human can install it.
- Can not be installed on the uneven and shaky surface
- In front of the sensor there shouldn't be obstructive object affecting detection.
- Avoid installing it near the metal and glass which may affect the sensor.
- For your safety, please don't open the case if you find hitch after installation.
- In order to avoid the unexpected damage of product, please add a safe device of current 6A when installing microwave sensor, for example, fuse, safe tube etc.

## **SOME PROBLEM AND SOLVED WAY**

- **The load don't work:**

- a. Check the power and the load.
- b. Whether the indicator light is turned on after sensing? If yes, please check load.
- c. If the indicator light is not on after sensing, please check if the working light corresponds to the ambient light.
- d. Please check if the working voltage corresponds to the power source.

- **The sensitivity is poor:**

- a. Please check if in front of the sensor there shouldn't be obstructive object that affect to receive the signals.
- b. Please check if the signal source is in the detection fields.
- c. Please check the installation height.

- **The sensor can't shut automatically the load:**

- a. If there are continual signals in the detection fields.
- b. If the time delay is set to the longest.
- c. If the power corresponds to the instruction.

---

RoHS



UK  
CA

